

PLAN ET ELEVATIONS D'UN LIT DE CAMPAGNE avec ses Developpements.

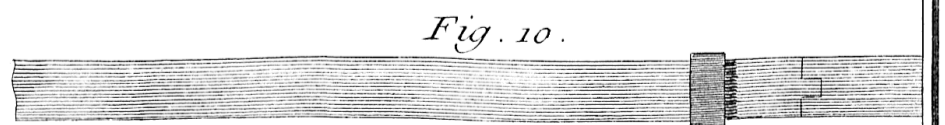
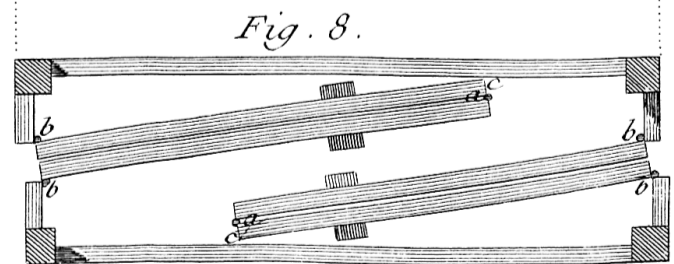
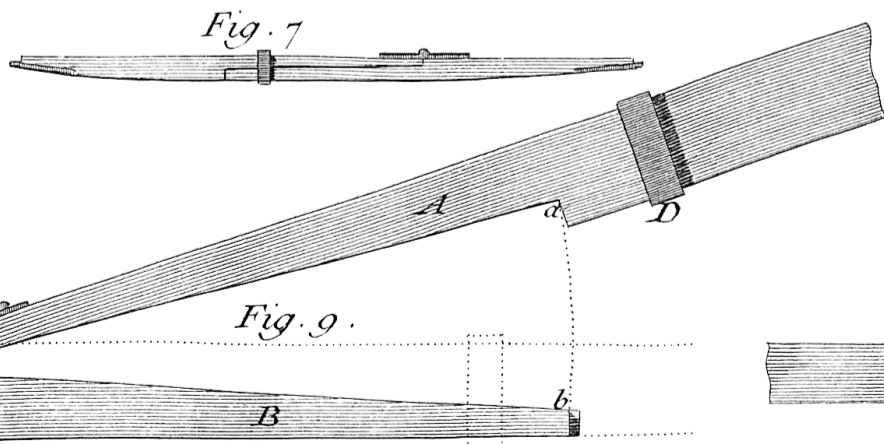
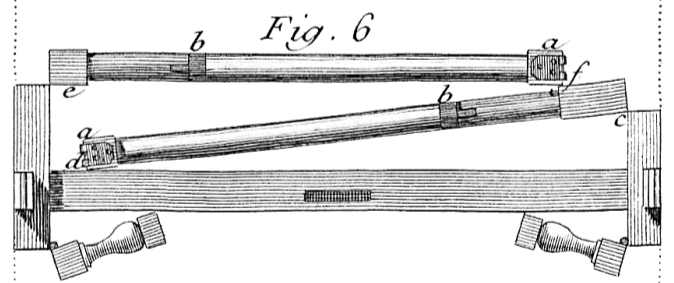
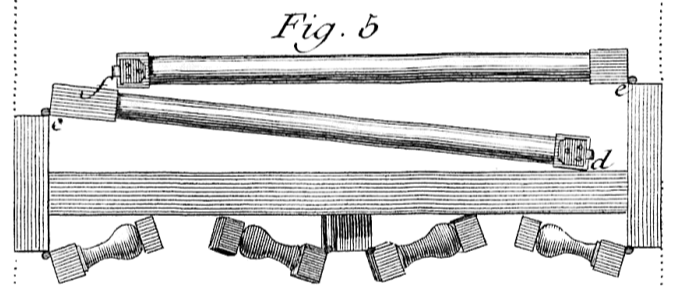
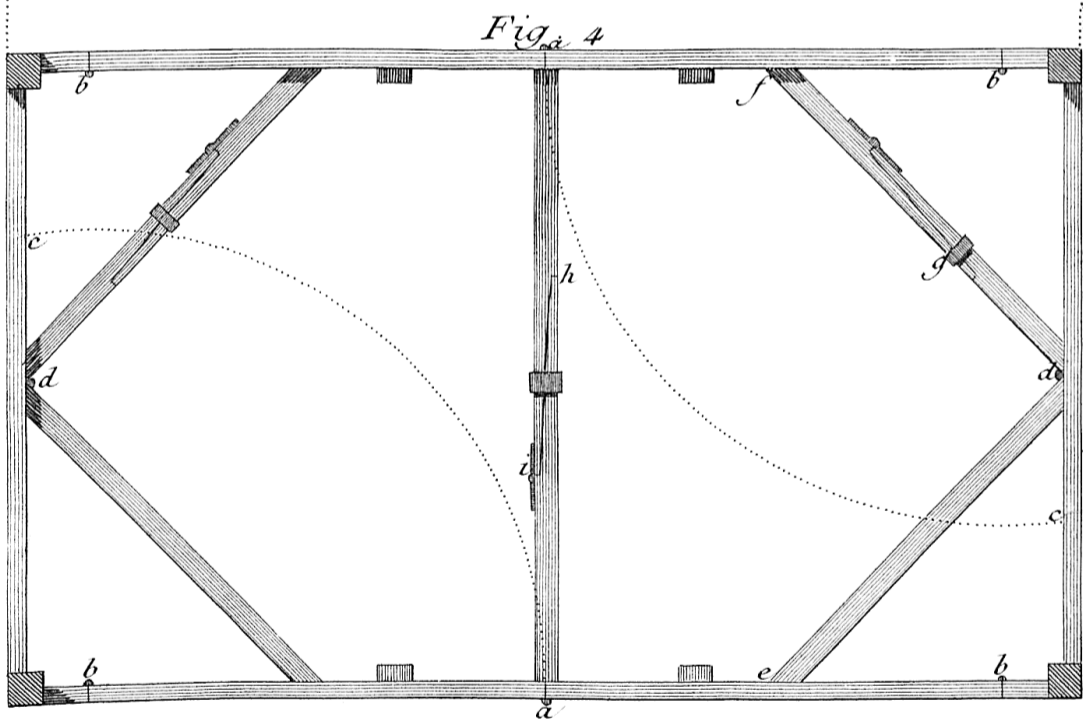
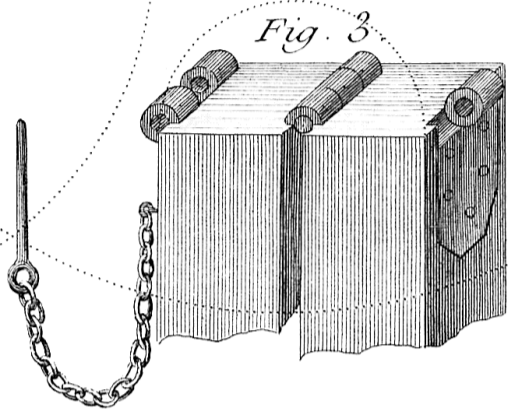
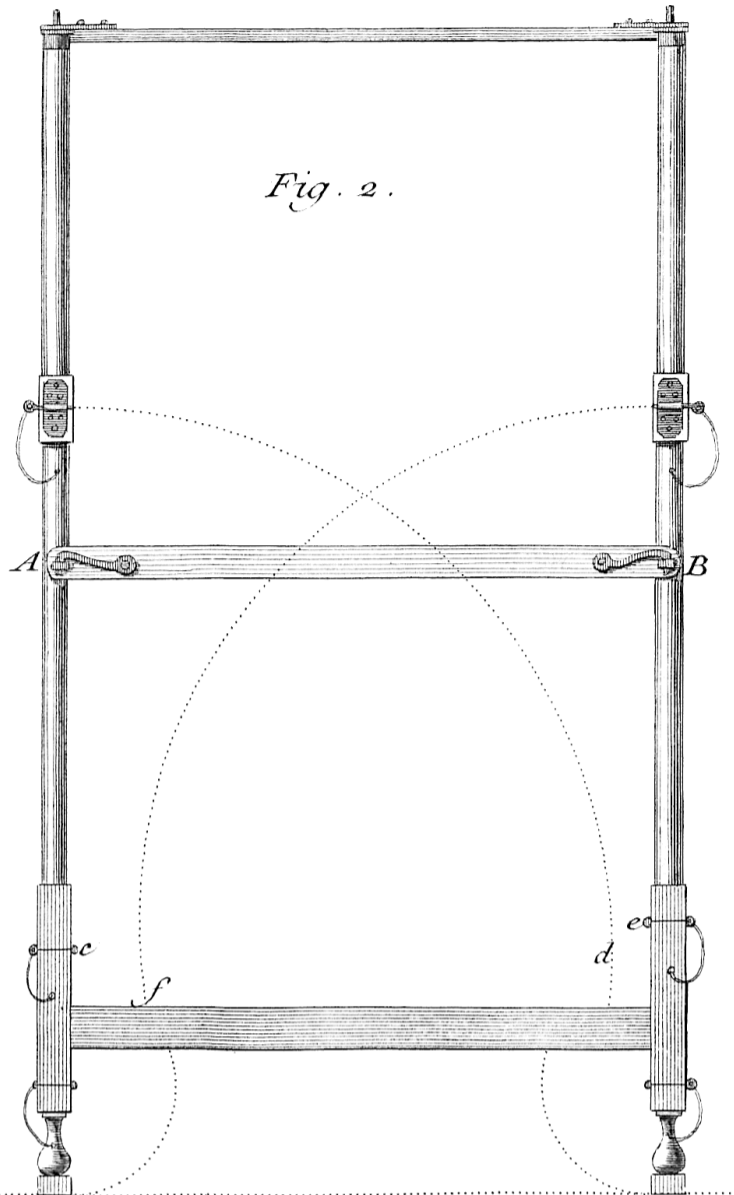
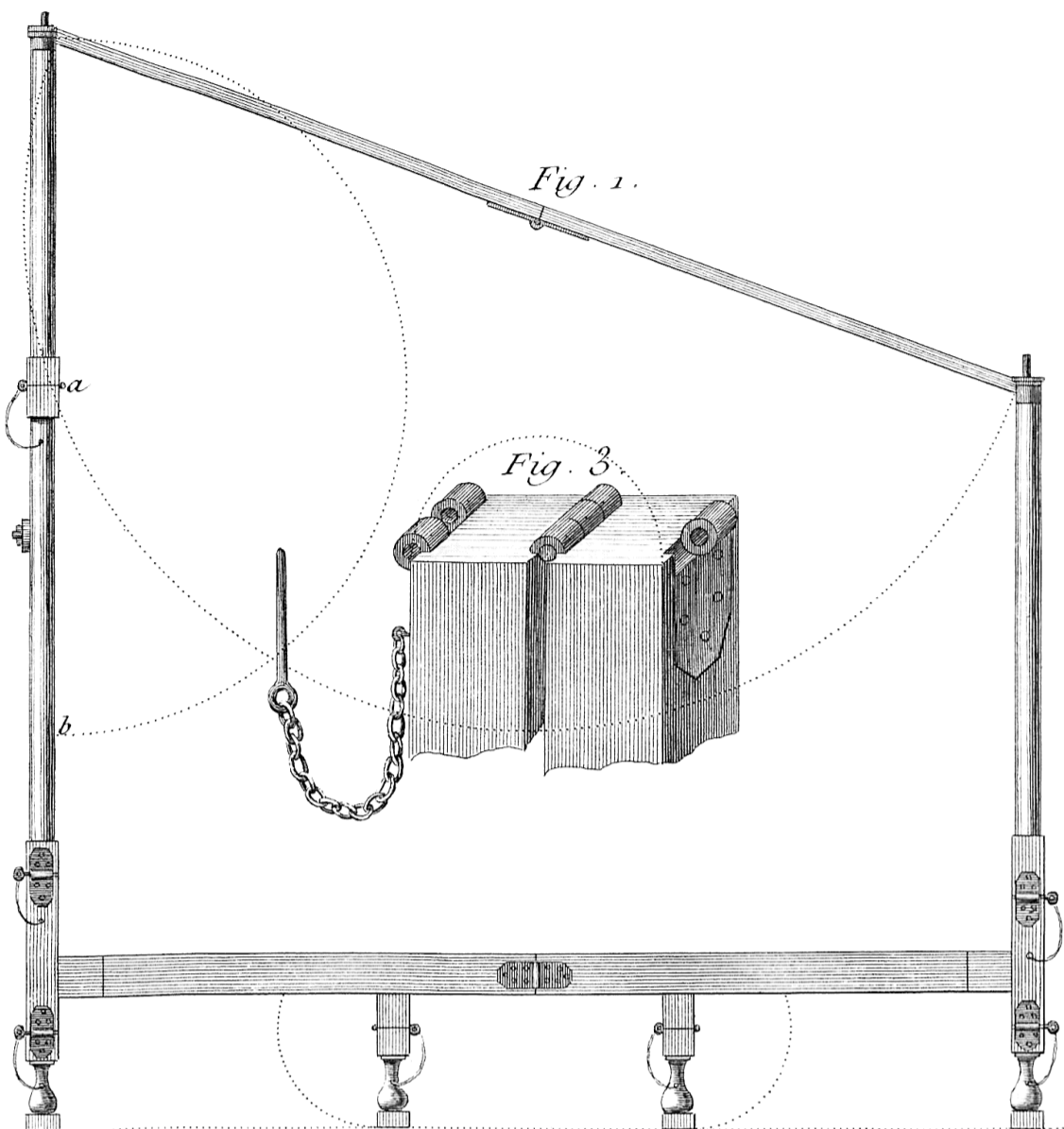

Echelles de 3 6 9 12 Pouces. 6 Pieds.